



RRDJCD10W

DJ Coffin w/ Wheels for 2 CD
Players: CDJ100, CDJ800, Denon
DN S 5000, DN S 3000 or Technics
SL-DZI200 and a 10" Mixer



Rugged Road Ready

Features

- * Beefy, Stackable Ball Corners
- * Double Anchor Industrial Rivets
- * Recessed, Industrial Grade Latches
- * Recessed Industrial Grade Handles
- * Industrial Grade Rubber Feet
- * Premium 3/8" Vinyl Laminated Plywood
- * Tongue and Groove Locking Fit
- * Front Access Panels
- * Rear Access Cable Port
- * Low Profile Wheels
- * ATA 300 Rating
- * Road Ready Limited Lifetime Warranty

Product Dimensions

Shipping Dimensions (inch): 41.7 x 19.2 x 10.4

Shipping Weight (lbs): 45.1

Product Dimensions (inch): 41.1 x 18.7 x 9.6

Product Weight (lbs): 40.7

Shipping Dimensions (cm): 106 x 49 x 26.5

Shipping Weight (kg): 20.5

Product Dimensions (cm): 104.5 x 47.5 x 24.6

Product Weight (kg): 18.5

Definitive protection for your gear, the RRDJCD10W is a real heavy hitter. Built to take on the streets the RRDJCD10W is designed to hold the CDJ1000, CDJ800 or DN S5000, DN S3000 or Technics SL-DZI200 CD players and a 10 inch mixer. The RRDJCD10W is built smart with Rugged Road Ready features like low profile wheels for sleek, stealth mobility, smart front access panels for easy CD player and mixer access and rear access cable port for hassle free connections. Go ahead give it a pounding!

Road Ready Cases

1226 Corral Place * Santa Fe Springs, CA 90670

ph: 562.906.6185 * fax: 562.906.6186

WWW.ROADREADYCASES.COM

RRDJCD10W

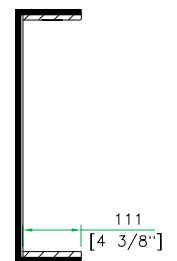
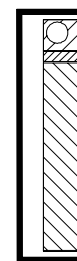
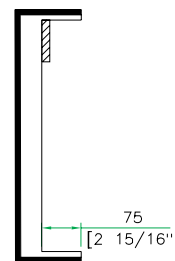
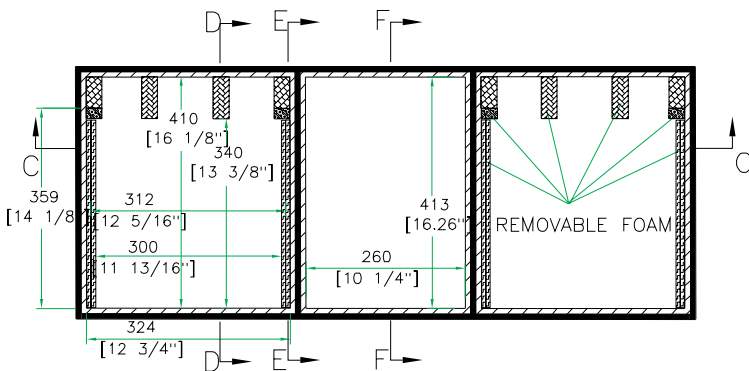
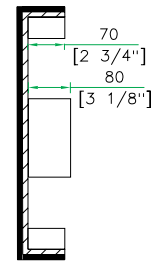
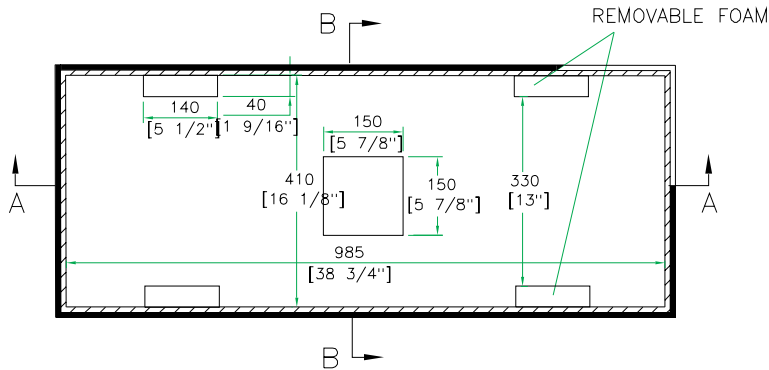
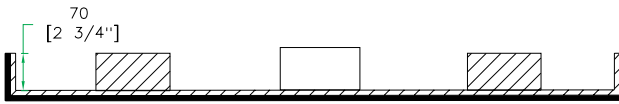
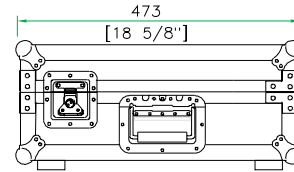
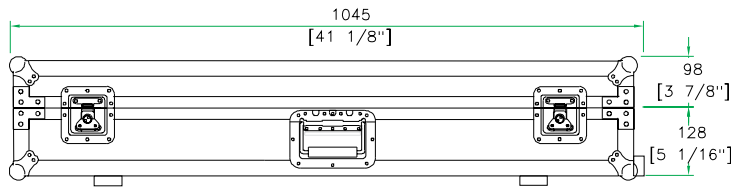
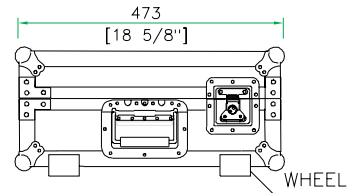
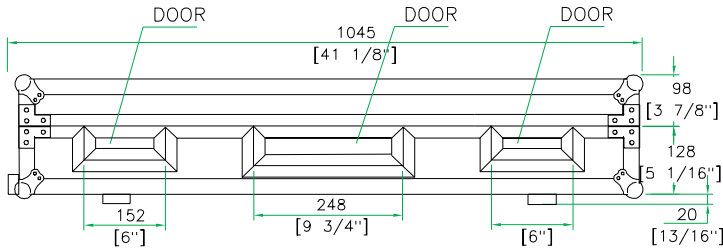

TOP VIEW OF BASE

D-D VIEW

E-E VIEW

F-F VIEW